

Standard fastening material

T-headed bolt HS 26/90

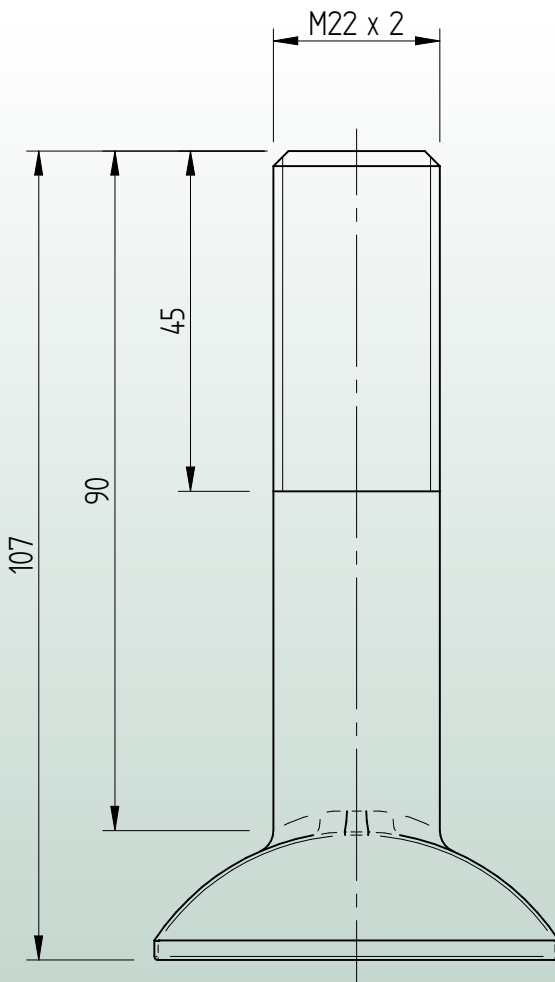
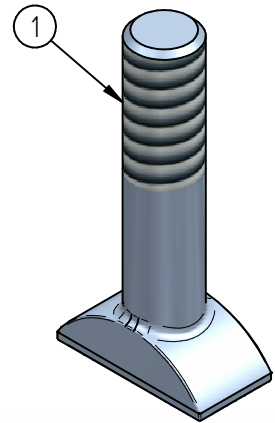
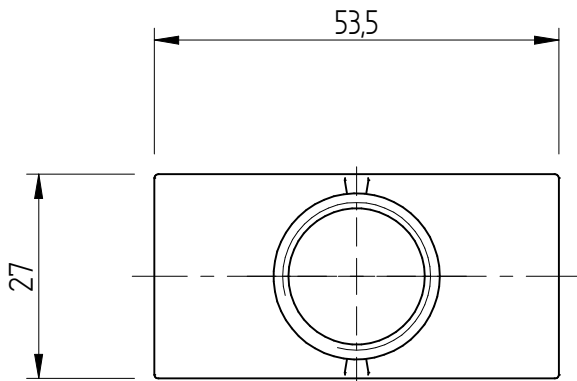

* Standard preservation is hot dip galvanized or self-coloured.
Other preservation and grade options in agreement.

1	T bolt	S235JR Grade 4,6*	Hs 26/90		m = 0,344 [kg]
Item	Description	Material	Type / Dimensions	Norm	Comments